

- > **Port size: 3/4" ... 1 1/2"**
(ISO G/ PTF)
- > **Complete air processing units pre-assembled, ready to install**



Technical features

Medium:

Compressed air only

Maximum operating pressure:

17 bar (246 psi)

Pressure range:

0,4 ... 8 bar (5 ... 116 psi)

Port sizes:

G3/4, G1, G1 1/4 or G1 1/2

Gauge ports:

Rc 1/8

Relieving:

Standard

Filter element:

40 µm;

Drain:

Manual or automatic

Automatic drain conditions:

Pressure to close drain:

> 0,3 bar (4.3 psi)

Pressure to open drain:

< 0,2 bar (2.9 psi)

Minimum air flow to close drain:

0,6 dm³/s (1.3 scfm)

Bowl size (lubricator):

0,5 litre (17 fluid oz)

Ambient/Media temperature:

-20° ... +80°C (-4° ... +176°F)

Version with gauge:

-20° ... +65°C (-4° ... +149°F)

Air supply must be dry enough to avoid ice formation at temperatures below +2°C (+35°F).

Materials:

Body, bowl and yoke: Aluminium

Liquid level indicator: Pyrex

Filter element: Sintered plastic

Elastomers: NBR

Available versions on request

Pressure range:

0,3 ... 4 bar (4 ... 58 psi),

0,7 ... 17 bar (10 ... 246 psi)

Port size:

3/4 PTF, 1 PTF, 1 1/4 PTF,

1 1/2 PTF

Element:

5 µm

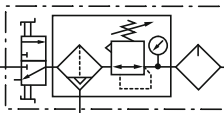
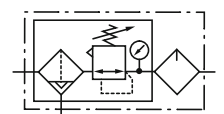

Technical data BL68 - standard models; automatic drain

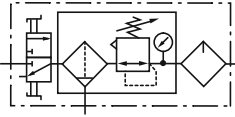
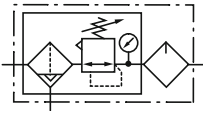

Symbol	Port size	Size	Pressure range (bar)	Element (µm)	Drain	Lubricator	Mounting	Gauge	Shut-off valve	Model
	G3/4	—	0,4 ... 8	40	Automatic	Micro fog	Bracket	With	With	BL68-601
	G1	Basic	0,4 ... 8	40	Automatic	Micro fog	Bracket	With	With	BL68-801
	G1 1/4	—	0,4 ... 8	40	Automatic	Micro fog	Bracket	With	With	BL68-A01
	G1 1/2	—	0,4 ... 8	40	Automatic	Micro fog	Bracket	With	With	BL68-B01
	G3/4	—	0,4 ... 8	40	Automatic	Oil fog	Bracket	With	With	BL68-611
	G1	Basic	0,4 ... 8	40	Automatic	Oil fog	Bracket	With	With	BL68-811
	G1 1/4	—	0,4 ... 8	40	Automatic	Oil fog	Bracket	With	With	BL68-A11
	G1 1/2	—	0,4 ... 8	40	Automatic	Oil fog	Bracket	With	With	BL68-B12
	G3/4	—	0,4 ... 8	40	Automatic	Micro fog	Bracket	With	Without	BL68-605
	G1	Basic	0,4 ... 8	40	Automatic	Micro fog	Bracket	With	Without	BL68-805
	G1 1/4	—	0,4 ... 8	40	Automatic	Micro fog	Bracket	With	Without	BL68-A05
	G1 1/2	—	0,4 ... 8	40	Automatic	Micro fog	Bracket	With	Without	BL68-B06
	G3/4	—	0,4 ... 8	40	Automatic	Oil fog	Bracket	With	Without	BL68-615
	G1	Basic	0,4 ... 8	40	Automatic	Oil fog	Bracket	With	Without	BL68-815
	G1 1/4	—	0,4 ... 8	40	Automatic	Oil fog	Bracket	With	Without	BL68-A15
	G1 1/2	—	0,4 ... 8	40	Automatic	Oil fog	Bracket	With	Without	BL68-B16

Technical data BL68 - standard models, manual drain

Symbol	Port size	Size	Pressure range (bar)	Element (µm)	Drain	Lubricator	Mounting	Gauge	Shut-off valve	Model
	G3/4	—	0,4 ... 8	40	Manual	Micro fog	Bracket	With	With	BL68-621
	G1	Basic	0,4 ... 8	40	Manual	Micro fog	Bracket	With	With	BL68-821
	G1 1/4	—	0,4 ... 8	40	Manual	Micro fog	Bracket	With	With	BL68-A21
	G1 1/2	—	0,4 ... 8	40	Manual	Micro fog	Bracket	With	With	BL68-B22
	G3/4	—	0,4 ... 8	40	Manual	Oil fog	Bracket	With	With	BL68-631
	G1	Basic	0,4 ... 8	40	Manual	Oil fog	Bracket	With	With	BL68-831
	G1 1/4	—	0,4 ... 8	40	Manual	Oil fog	Bracket	With	With	BL68-A31
	G1 1/2	—	0,4 ... 8	40	Manual	Oil fog	Bracket	With	With	BL68-B32
	G3/4	—	0,4 ... 8	40	Manual	Micro fog	Bracket	With	Without	BL68-625
	G1	Basic	0,4 ... 8	40	Manual	Micro fog	Bracket	With	Without	BL68-825
	G1 1/4	—	0,4 ... 8	40	Manual	Micro fog	Bracket	With	Without	BL68-A25
	G1 1/2	—	0,4 ... 8	40	Manual	Micro fog	Bracket	With	Without	BL68-B26
	G3/4	—	0,4 ... 8	40	Manual	Oil fog	Bracket	With	Without	BL68-635
	G1	Basic	0,4 ... 8	40	Manual	Oil fog	Bracket	With	Without	BL68-835
	G1 1/4	—	0,4 ... 8	40	Manual	Oil fog	Bracket	With	Without	BL68-A35
	G1 1/2	—	0,4 ... 8	40	Manual	Oil fog	Bracket	With	Without	BL68-B36

Accessories

	3/2 Shut-off valve Threaded inlet only	Threaded outlet only	Bracket mounting
			
Thread			
G3/4	T68H-6GB-B2N	T68H-6GC-B2N	18-001-979
G1	T68H-8GB-B2N	T68H-8GC-B2N	18-001-979
G1 1/4	T68H-AGB-B2N	T68H-AGC-B2N	18-001-978
G1 1/2	T68H-BGB-B2N	T68H-BGC-B2N	18-001-972
3/4 PTF	T68H-6AB-B2N	T68H-6AC-B2N	18-001-979
1 PTF	T68H-8AB-B2N	T68H-8AC-B2N	18-001-979
1 1/4 PTF	T68H-AAB-B2N	T68H-AAC-B2N	18-001-978
1 1/2 PTF	T68H-BAB-B2N	T68H-BAC-B2N	18-001-972

Tamper resistant cap & seal wire	Porting block	Padlock with two keys
		
4355-51	18-026-986 (G1/4 & G1/2) 18-026-983 (1/4 & 1/2 NPT)	0613633 (brass)

Dimensions with shut-off valve

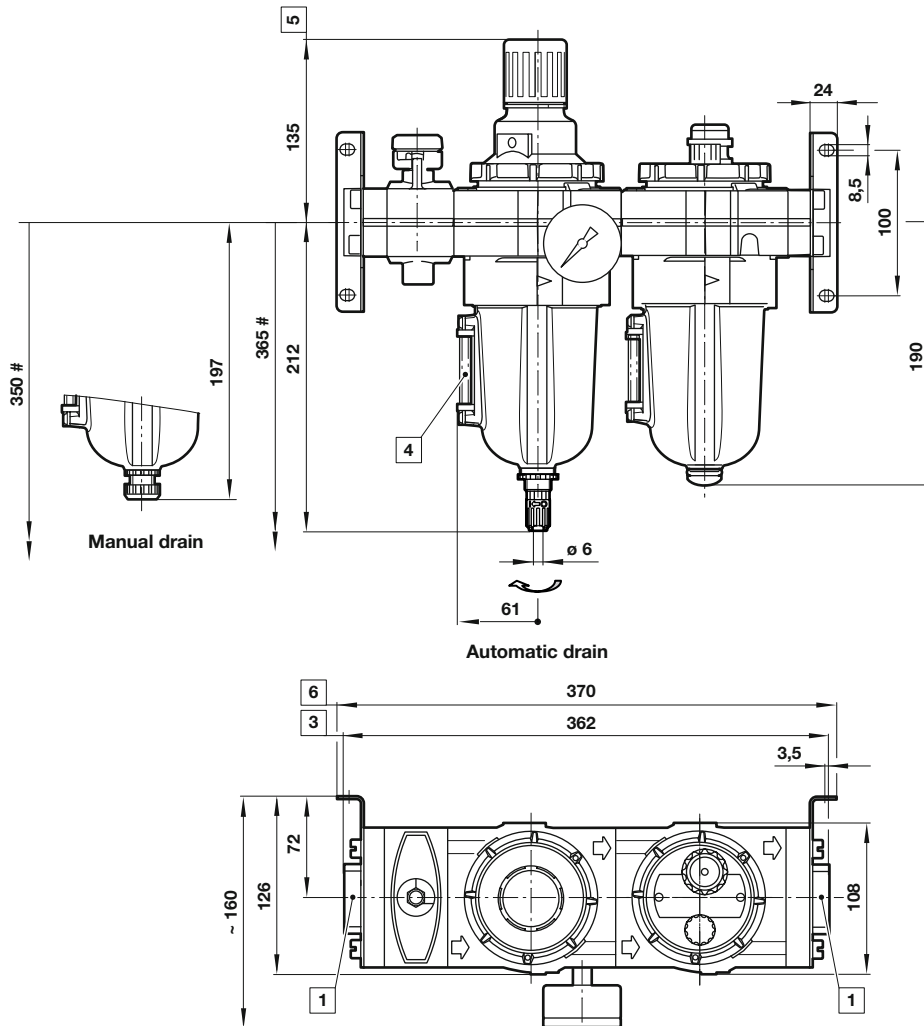
 Dimensions in mm
 Projection/First angle

- # Minimum clearance required to remove bowl
- 1 Main ports 3/4", 1", 1 1/4" or 1 1/2"
 - 3 Plus 10 mm for ports 1 1/4" or 1 1/2"
 - 4 Sight glass
 - 5 Reduces by 4 mm with knob in locked position
 - 6 Plus 10 mm for ports 1 1/4"

Dimensions without shut-off valve

Dimensions in mm
Projection/First angle

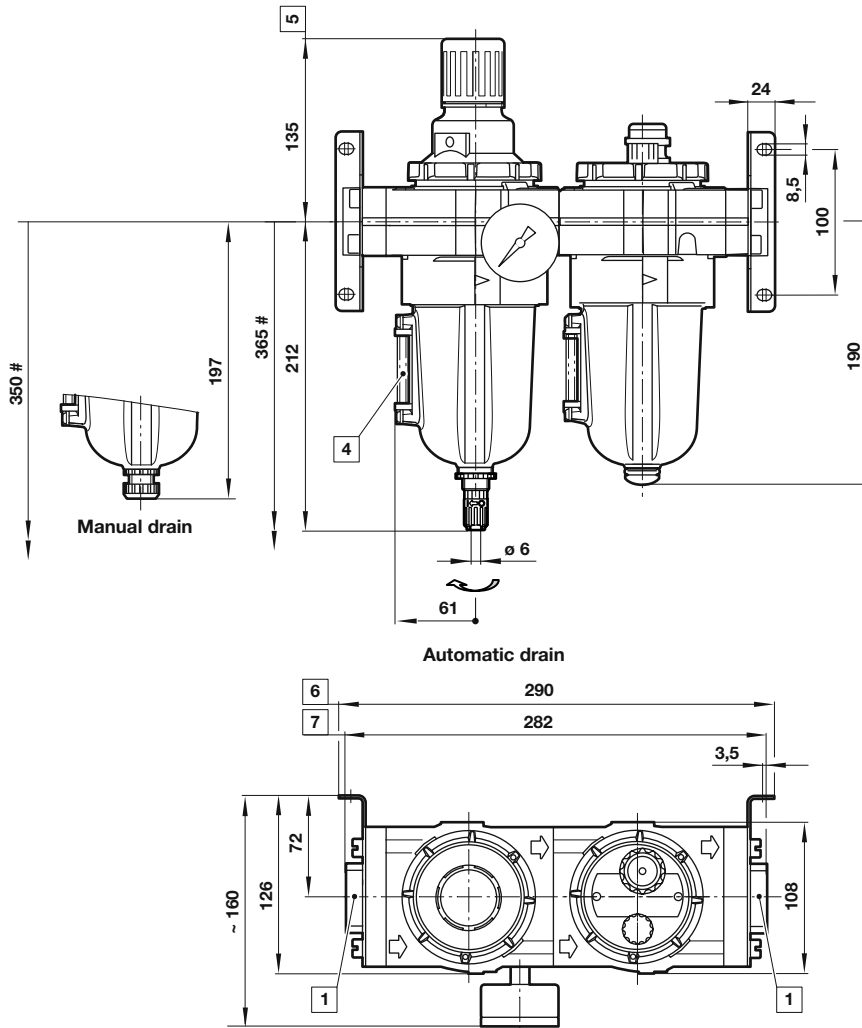

- # Minimum clearance required to remove bowl
- 1 Main ports 3/4", 1", 1 1/4" or 1 1/2"
- 4 Sight glass
- 5 Reduces by 4 mm with knob in locked position
- 6 Plus 10 mm for ports 1 1/4"
- 7 Plus 10 mm for ports 1 1/4" and 5 mm for 1 1/2"

3/2 Shut-off valve

Porting block

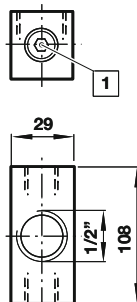
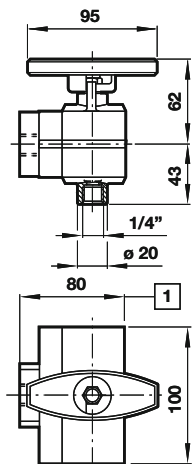

1 For 1 1/2" ported yokes add 5 mm

1 Two additional plugged 1/4" ports

Warning

These products are intended for use in industrial compressed air systems only. Do not use these products where pressures and temperatures can exceed those listed under »**Technical features/data**«.

Before using these products with fluids other than those specified, for non-industrial applications, life-support systems or other applications not within published specifications, consult IMI Precision Engineering, IMI International s.r.o.

Through misuse, age, or malfunction, components used in fluid power systems can fail in various modes. The system designer is warned to consider the failure modes of all component parts used in fluid power systems and to provide adequate safeguards to prevent personal injury or damage to equipment in the event of such failure.

System designers must provide a warning to end users in the system instructional manual if protection against a failure mode cannot be adequately provided.

System designers and end users are cautioned to review specific warnings found in instruction sheets packed and shipped with these products.