

## T60 Air fuse , in-line excess flow shut-off valves

- Port size: G1/4 ... G1 1/2
- Assists in complying with safety regulations
- Tamper proof
- Compact and safe design
- Low pressure drop.
- Automatically resets after failure correction
- High corrosion resistance
- High air pressure rating



### Technical features

#### Medium:

Compressed air, filtered, lubricated and non-lubricated, inert gases

#### Operation:

Fixed uni-directional excess flow automatic shut off valve.

#### Operating pressure:

16 bar max. (232 psi)  
Minimum according to hose length. Drop pressure at shut-off

flow . 0,14 or 0,3 bar (2 or 4 psi)

#### Port size:

G1/4, G3/8, G1/2, G3/4, G1, G1 1/2

#### Mounting:

In-line two ways valve  
To be inserted between fixed air supply and flexible hose air line  
See guidelines for typical installation

#### Ambient/Media temperature:

-20 ... +80°C max. (-4 ... +176°F)  
Air supply must be dry enough to avoid ice formation at temperatures below +2°C (+35°F)

#### Materials:

Body: Aluminium  
Internal parts: Brass  
Spring: Stainless steel

### Technical data, standard models

Function	Port size	Drop pressure at shut off flow (bar)	Shut off flow rate at 7 bar (dm <sup>3</sup> /s) ±10%	Flow at 7 bar Δ p 0,07 bar (dm <sup>3</sup> /s)	Weight (kg)	Model
	G1/4	0,14	8,3	6,5	0,041	T60C2890
	G1/4	0,3	14	6,5	0,041	T60C2891
	G3/8	0,14	19,4	13,5	0,065	T60C3890
	G3/8	0,3	32,2	13,5	0,065	T60C3891
	G1/2	0,14	32,2	23,2	0,150	T60C4890
	G1/2	0,3	48,3	23,2	0,150	T60C4891
	G3/4	0,14	48,3	43	0,130	T60C6890
	G3/4	0,3	80	43	0,130	T60C6891
	G1	0,14	92	68	0,540	T60C8890
	G1	0,3	128	68	0,540	T60C8891
	G1 1/2	0,14	186	145	1,1	T60CB890
	G1 1/2	0,3	268	145	1,1	T60CB891

Flow and pressure test conducted according to ISO 6358 test circuit. Mean measured flow values are provided at standard reference conditions.

### Options selector

Thread	Substitute	T60★★★★★		Flow range	Substitute
ISO G, parallel	C			0,14	90
NPT	A			0,3	91
				Port size	Substitute
				1/4"	28
				3/8"	38
				1/2"	48
				3/4"	68
				1"	88
				1 1/2"	B8

## Minimum pressure required to shut off the air supply - check failure flow conditions

Hose length vs minimum pressure supply (1/4" ... 3/8")

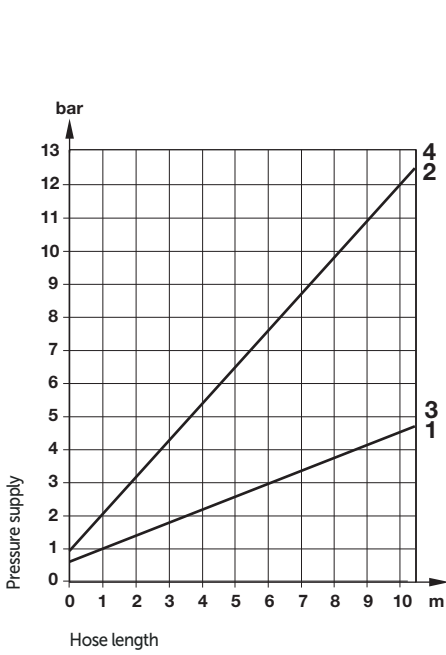

- 1 T60 \* 2890 (ID = 6,6mm)
- 2 T60 \* 2891 (ID = 6,6mm)
- 3 T60 \* 3890 (ID = 9,0mm)
- 4 T60 \* 3891 (ID = 9,0mm)

Hose length vs minimum pressure supply (1/2" ... 3/4")

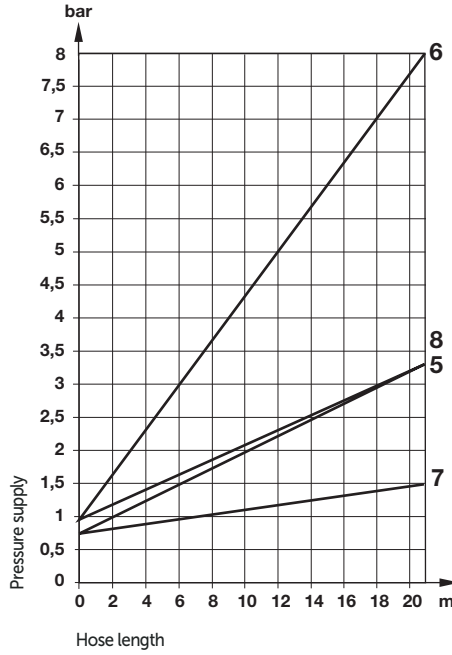

- 5 T60 \* 4890 (ID = 13mm)
- 6 T60 \* 4891 (ID = 13mm)
- 7 T60 \* 6890 (ID = 19mm)
- 8 T60 \* 6891 (ID = 19mm)

Hose length vs minimum pressure supply (1" ... 1 1/2")

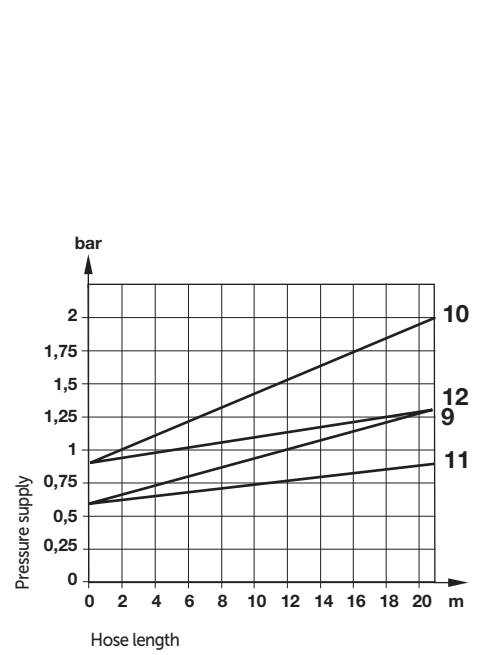

- 9 T60 \* 8890 (ID = 25,4mm)
- 10 T60 \* 8891 (ID = 25,4mm)
- 11 T60 \* B890 (ID = 38,1mm)
- 12 T60 \* B891 (ID = 38,1mm)

## Flow required to shut off air supply – check normal flow conditions

Flow ( $\pm 10\%$ ) vs pressure supply (1/4 ... 1/2")

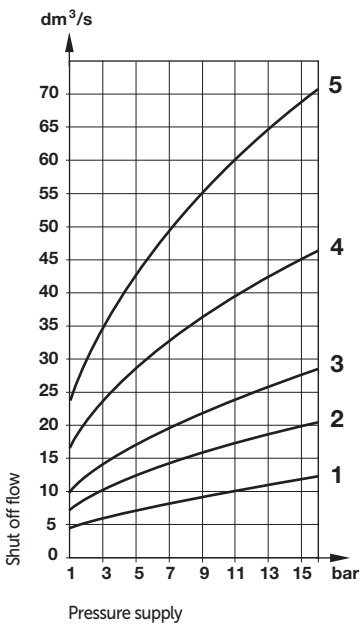

- 1 T60 \* 2890
- 2 T60 \* 2891
- 3 T60 \* 3890
- 4 T60 \* 3891
- 5 T60 \* 4890
- 6 T60 \* 4891

Flow ( $\pm 10\%$ ) vs pressure supply (3/4 ... 1 1/2")

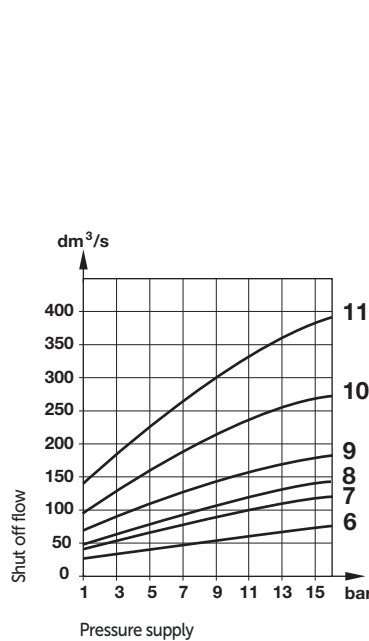

- 6 T60 \* 6890
- 7 T60 \* 6891
- 8 T60 \* 8890
- 9 T60 \* 8891
- 10 T60 \* B890
- 11 T60 \* B891

### Measurements

Flow and pressure tests conducted according to ISO-6358 test circuit. Mean measured flow values are provided at standard reference condition (20°C, 1,01 bar). Indicated pressure values are relative pressure in bar.

### Hose lengths

Graphs are for indicated hose internal diameter in key. Consult our Technical Service for hose lengths and internal diameters different from the recommended one.

### Guidelines for typical installation

The Air Fuse should be installed directly between fixed or rigid pipework and the flexible tube to protect the whole length of the flexible tube. Only tubing after the Air Fuse is protected. The Air Fuse must be installed in the correct direction for Airflow. Failure to do this will render the Air Fuse ineffective. When a shut off valve is located before the Air Fuse, the valve must be opened slowly in order to control initial air flow and avoid decompression effects which may trip the Air Fuse.

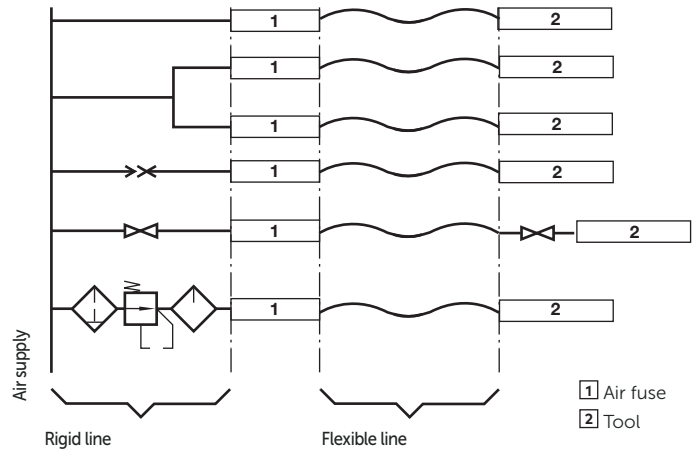

### How to select an air fuse

- The Port size of the Air Fuse should be nominally equal to that of the supply lines - eg a 1/2" (12.7mm) Air Fuse should be used with a 1/2" (12.7mm) ID hose.
- Always select the high flow model (91) if there is sufficient system pressure for the length of hose to be protected. See tables hose length vs minimum supply pressure.
- If there is insufficient system pressure, or long hose lengths are to be protected, use model 90.
- After installation always test each valve for proper function. See section how to check an Air Fuse below.
- The pneumatic system must be capable of delivering the flow required to activate the Air Fuse.
- For use with spring coils consult table. See table flow vs pressure supply.

### How to check an air fuse

- \* Install Air Fuse following the instructions supplied
- \* Connect tool or complete circuit to the air line
- \* Switch on operation to ensure a complete cycle is performed
- \* If tool or complete circuit starts and runs satisfactorily, stop operation and drain air line. Disconnect hose from tool or circuit and secure hose end. Turn on air supply progressively (to avoid decompression effect). Prior to fully reaching operation conditions, the valve should suddenly activate and cut off the flow. A slight air flow will remain as part of the automatic re-set function. If the Air fuse is not activated the unit should be disconnected and the lower flow range Air Fuse should be used.

### Spring coils and air fuse minimum required pressure (bar)

Air Fuse T60C2890	T60C2891	T60C3890	T60C3891	T60C4890	T60C4891	Spring Coils Model
4,1						PA330800328
5,4						PA330800428
1,0	2,5	4,8				PA331000328
1,2	3,3	6,4				PA331000428
1,5	4,2					PA331000528
2,2	6,2					PA331000828
4,4						PA331001528
0,7	0,9	1,5	4,1			PA331200338
0,7	1,0	2,0	5,4			PA331200438
0,7	1,3	2,4				PA331200538
0,7	1,9	3,7				PA331200838
1,4	3,8					PA331201538
0,7	0,9	0,7	1,5	1,5	3,5	PA331500348
0,7	0,9	0,7	2,1	2,1	4,6	PA331500448
0,7	0,9	0,9	2,6	2,6	5,8	PA331500548
0,7	0,9	1,4	3,8	3,8		PA331500848
5,4						PU310800228
1,3	3,8					PU311000228
2,7						PU311000428
5,0						PU311000628
6,0						PU311000828
0,7	1,2	2,4	6,6			PU311200238
0,9	2,5	4,8				PU311200438
1,3	3,7					PU311200638
1,6	4,6					PU311200838

Note: Only the spring coils in these table can be protected by the air fuse!

## Dimensions

Dimensions in mm  
Projection/First angle

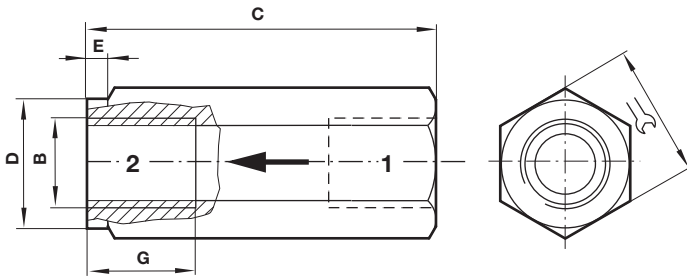

B	C	Ø D	E	G		Model
G1/4	51	20,5	3	11 (10)	21	T60C289
G3/8	62	24	5	14 (10,3)	24	T60C389
G1/2	78	32	5	15 (13,6)	32	T60C489
G3/4	90	32	5	19 (14,1)	32	T60C689
G1	118	51	5	25,5 (16,8)	51	T60C889
G1 1/2	145	63,5	5	25,5 (17,3)	64	T60CB89

Values in ( ) for NPT

## Warning

These products are intended for use in industrial compressed air systems only. Do not use these products where pressures and temperatures can exceed those listed under »**Technical features/data**«. Before using these products with fluids other than those specified, for non-industrial applications, life-support systems or other applications not within published specifications, consult Norgren Ltd.

Through misuse, age, or malfunction, components used in fluid power systems can fail in various modes.

The system designer is warned to consider the failure modes of all component parts used in fluid power systems and to provide adequate safeguards to prevent personal injury or damage to equipment in the event of such failure.

System designers must provide a warning to end users in the system instructional manual if protection against a failure mode cannot be adequately provided.

System designers and end users are cautioned to review specific warnings found in instruction sheets packed and shipped with these products.